

Matrix Plus - Installation Instructions

Models MP-XX & MMP-XX

Please read all instructions prior to installation and keep for future reference!

1. PRODUCT TO BE INSTALLED BY A QUALIFIED ELECTRICIAN.
2. PRIOR TO INSTALLATION ENSURE POWER IS OFF AT FUSE BOX TO PREVENT ELECTRICAL SHOCK.
3. ACCESS IS REQUIRED FOR SERVICE AND MAINTENANCE

Install the Matrix Plus panel

1

Note: Matrix can be cut along the dashed lines to configure into varies configurations. Reference step 2 for additional information.

- 1.1 Clean the area thoroughly from any dust and or adhesive residue where the Matrix will be installed. Reference steps 3-6 for additional mounting information .
- 1.2 Remove the paper backing from the Matrix. Carefully stick onto the surface firmly. Make sure there are no air bubbles or ripples that can cause irregularities and affect from sticking on correctly. If adhesive not sticking well to the surface. Reference step 4 to use mounting hardware (not included).

Note: When removing the backing & placing the Matrix to the surface, avoid any ripples. As shown in FIG. 1.

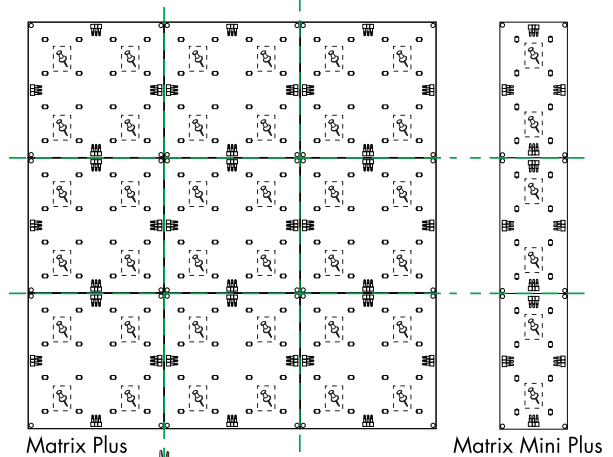
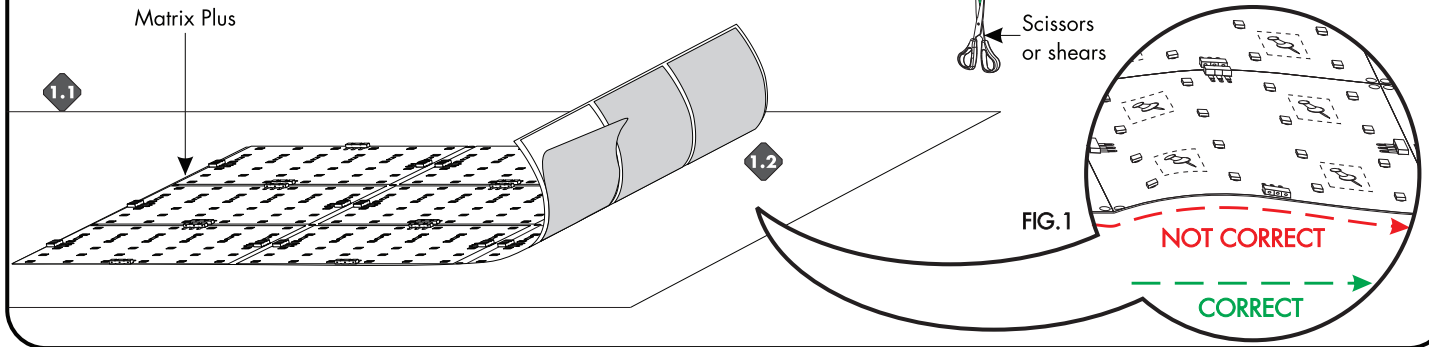

- Common Matrix Plus configurations

2

Note: Matrix Plus & Matrix Mini Plus can be installed in multiple configuration. Reference diagram below to see if your configuration is possible. When connecting to another Matrix Plus always connect all the corresponding female connectors, with a male adapter to achieve a proper connection.

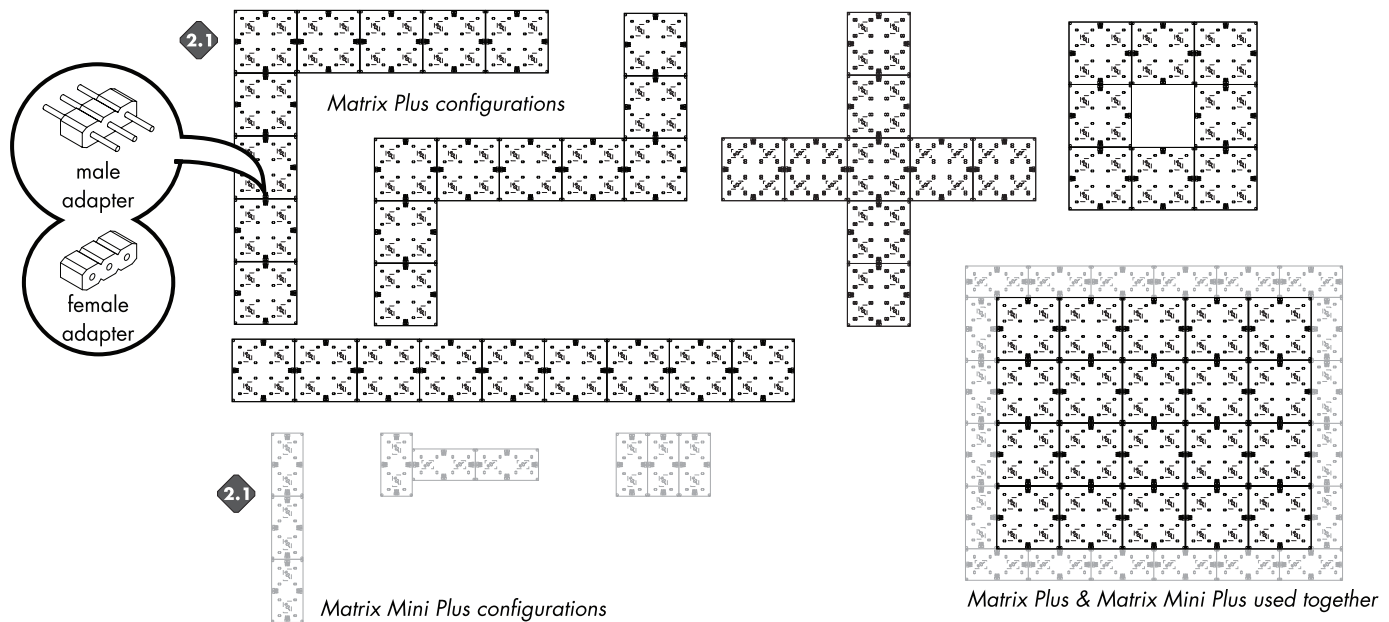

Matrix Plus - Installation Instructions

Models MP-XX & MMP-XX

Please read all instructions prior to installation and keep for future reference!

1. PRODUCT TO BE INSTALLED BY A QUALIFIED ELECTRICIAN.
2. PRIOR TO INSTALLATION ENSURE POWER IS OFF AT FUSE BOX TO PREVENT ELECTRICAL SHOCK.
3. ACCESS IS REQUIRED FOR SERVICE AND MAINTENANCE

- Connect to powerfeed

3

3.1 Connect the power feed wire into one of the female/male connectors that is soldered on the Matrix. By sliding and then pushing completing into the connector. Secure by placing clip (CL-1) over the connector and secure using the two screws. Reference diagram below for more details.

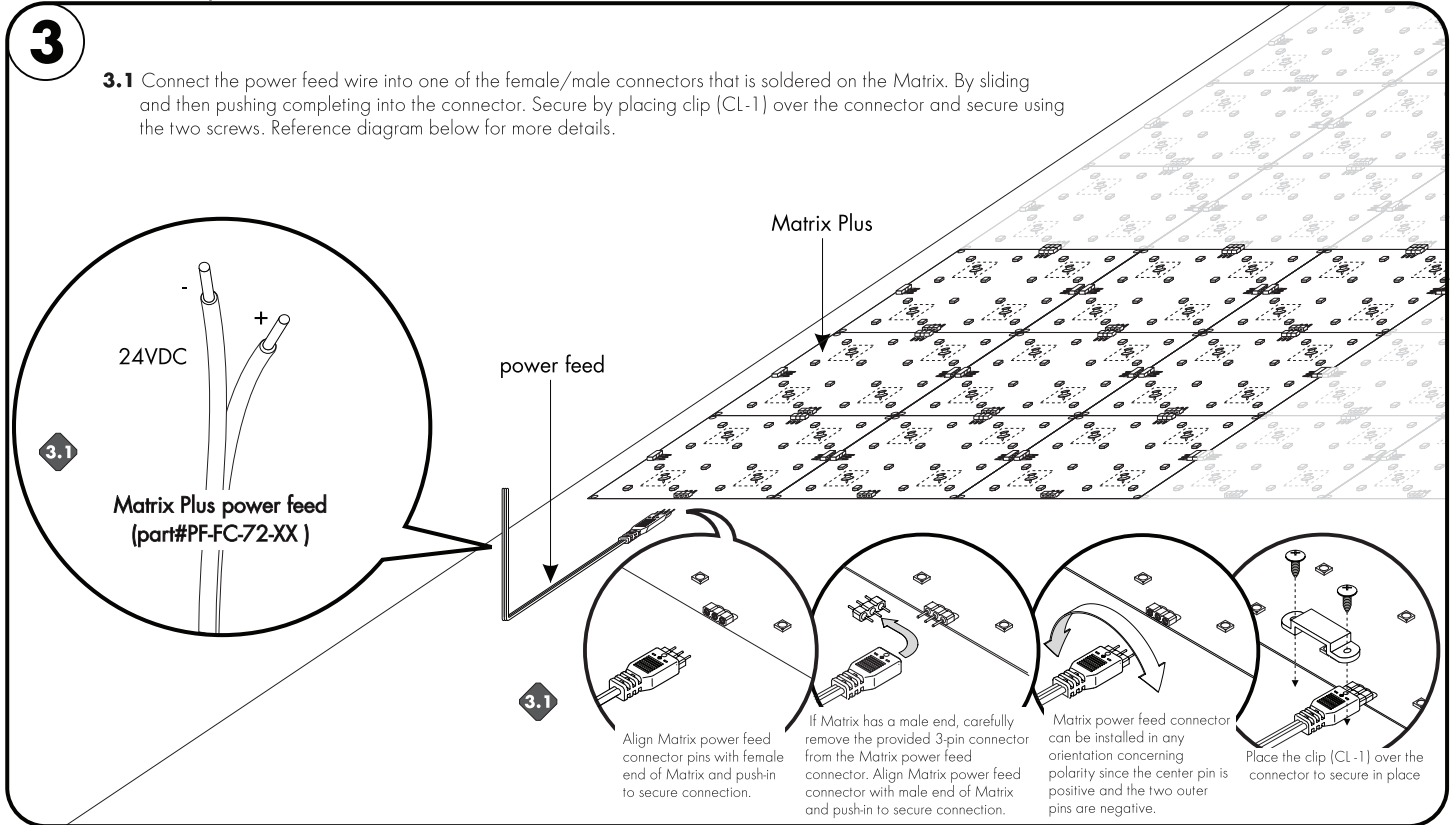

3.1 Matrix Plus power feed (part#PF-FC-72-XX)

24VDC

Matrix Plus

power feed

3.1

3.1

3.1

3.1

Align Matrix power feed connector pins with female end of Matrix and push-in to secure connection.

If Matrix has a male end, carefully remove the provided 3-pin connector from the Matrix power feed connector. Align Matrix power feed connector with male end of Matrix and push-in to secure connection.

Matrix power feed connector can be installed in any orientation concerning polarity since the center pin is positive and the two outer pins are negative.

Place the clip (CL-1) over the connector to secure in place

- Additional mounting information

4

4.1 Start install by securing the first Matrix panel, followed by removing the adhesive backing on the 2nd panel. Then align the 2nd Matrix panel male adapters to the female adapter of the 1st Matrix panel. Then carefully secure in place.

Note: When connecting to another Matrix Plus always connect all the corresponding female connectors, with a male adapter to achieve a proper connection.

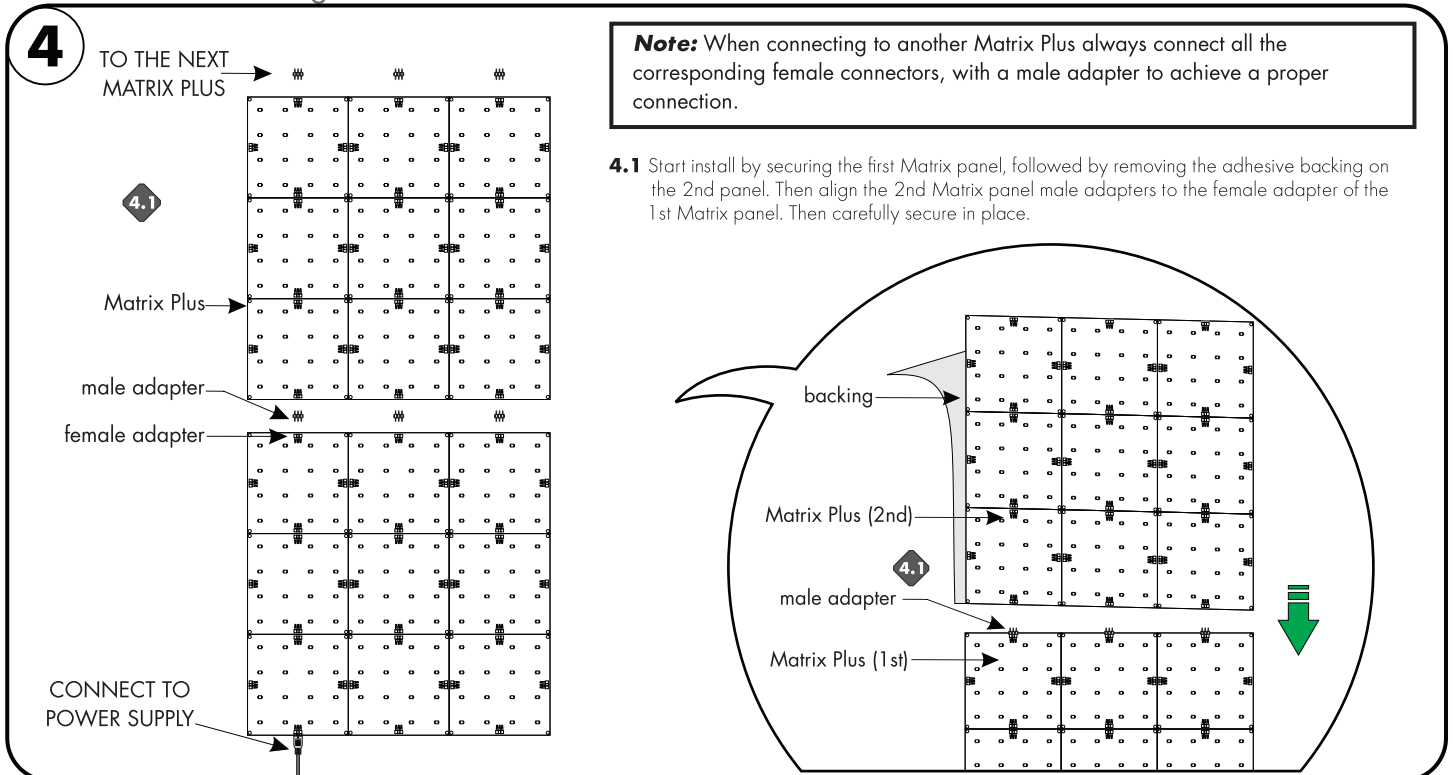

TO THE NEXT MATRIX PLUS

Matrix Plus

male adapter

female adapter

CONNECT TO POWER SUPPLY

backing

Matrix Plus (2nd)

male adapter

Matrix Plus (1st)

REVO.1 06062023

*LUMINII RESERVES THE RIGHTS TO CHANGE SPECIFICATION & INSTRUCTION WITHOUT NOTICE

Matrix Plus - Installation Instructions

Models MP-XX & MMP-XX

Please read all instructions prior to installation and keep for future reference!

1. PRODUCT TO BE INSTALLED BY A QUALIFIED ELECTRICIAN.
2. PRIOR TO INSTALLATION ENSURE POWER IS OFF AT FUSE BOX TO PREVENT ELECTRICAL SHOCK.
3. ACCESS IS REQUIRED FOR SERVICE AND MAINTENANCE

- Additional mounting information

5

OPTIONAL: There are 2 additional mounting options, when the adhesive tape is not sticking on to the surface properly. The first and easier solution is to use push-pins (if applicable). Only can be used in the areas on the board outlined with a push-pin illustration. The second is to use #0 screw size with an electrical insulating polypropylene plastic washer 0.065" ID, 0.188" OD. Insert the screw/washer through the Matrix Plus mounting holes to secure Matrix properly to surface.

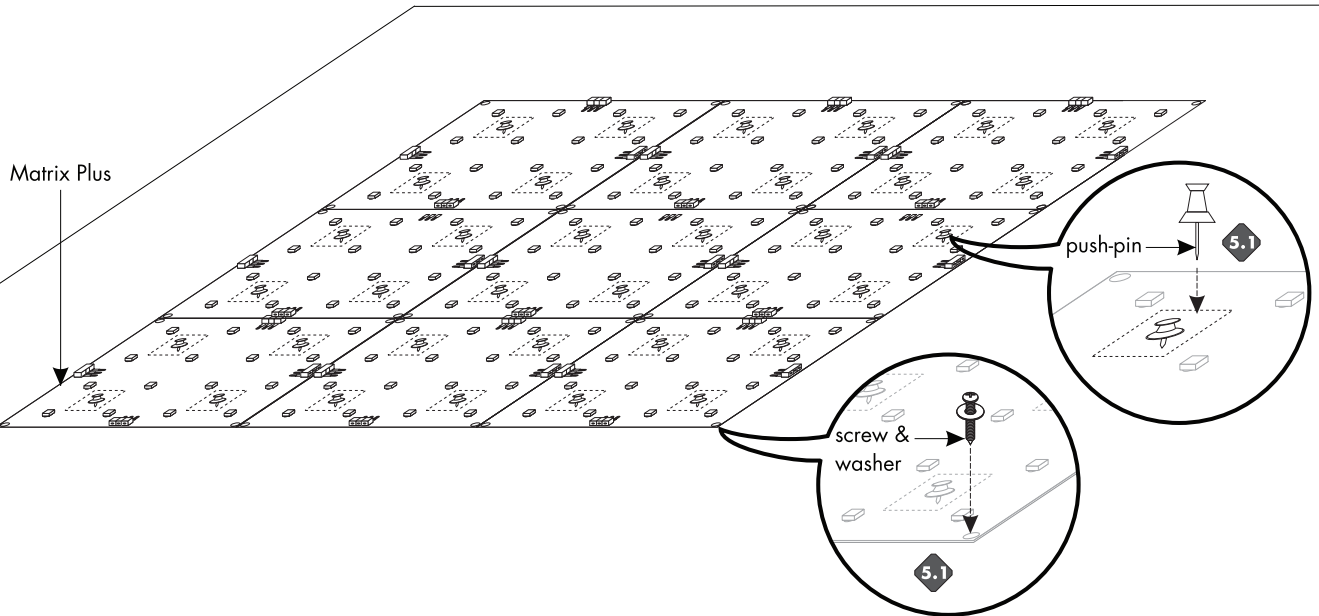

- Sample Layout

6

6.1 Refer to specifications below when installing the Matrix into an enclosed area.

- enclosure must have minimum of 1" depth, from where the matrix is installed.
- 3/4" holes must be made every 8" on the sides of surface, for air ventilation.

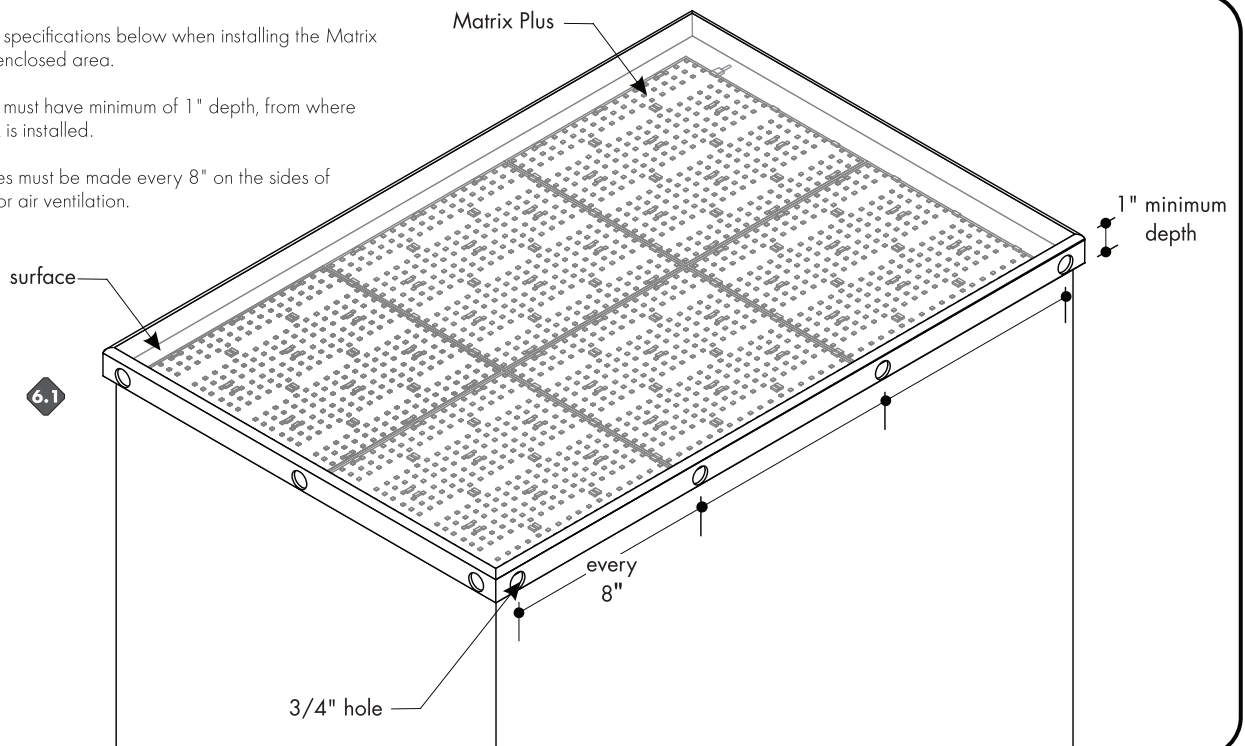

Matrix Plus - Installation Instructions

Models MP-XX & MMP-XX

Please read all instructions prior to installation and keep for future reference!

1. PRODUCT TO BE INSTALLED BY A QUALIFIED ELECTRICIAN.
2. PRIOR TO INSTALLATION ENSURE POWER IS OFF AT FUSE BOX TO PREVENT ELECTRICAL SHOCK.
3. ACCESS IS REQUIRED FOR SERVICE AND MAINTENANCE

- Wiring Diagram

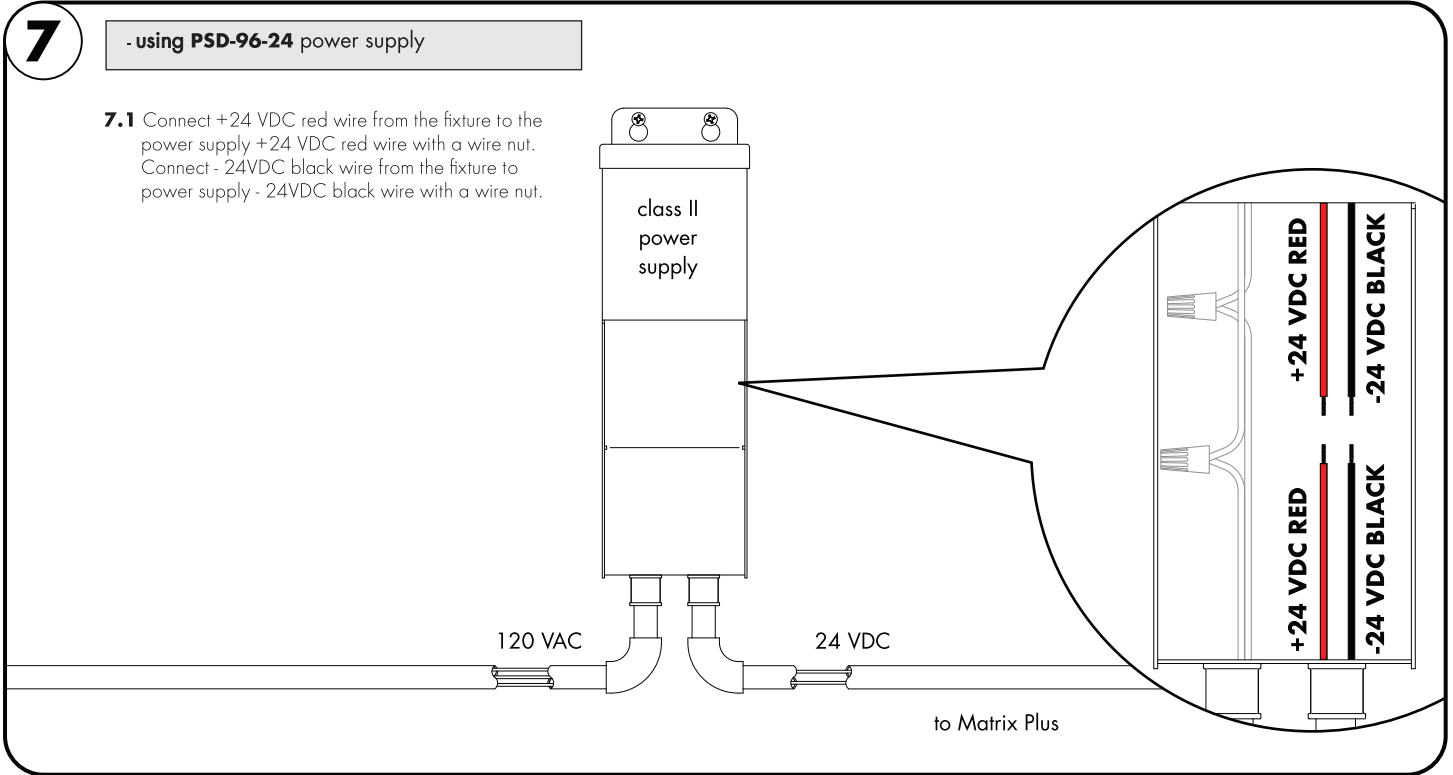

- Powerfeed locations

